



**Prefeitura de
Porto Alegre**

**MUNICÍPIO DE PORTO ALEGRE
DEPARTAMENTO DE ESGOTOS PLUVIAIS - DEP
EQUIPE DE LICITAÇÕES E CONTRATOS – ELC**



Situação 2008

Situação atual

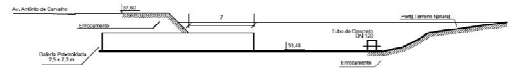
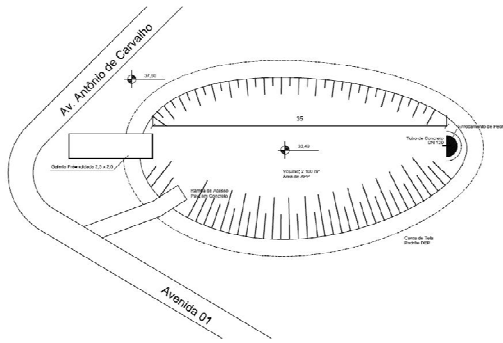

Reservatório 20: Rossi América 2

Planta de Localização



Situação 2008

Situação atual

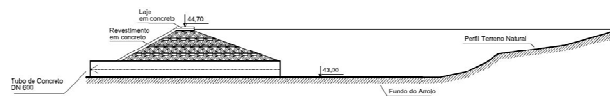
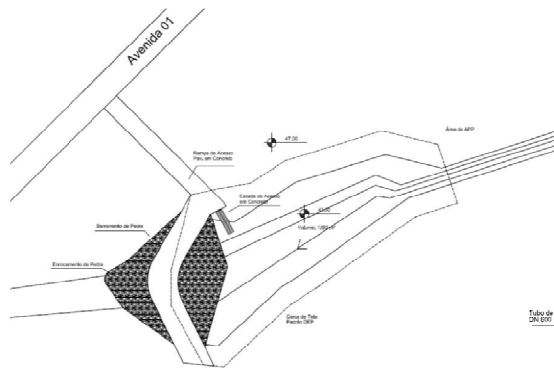

Reservatório 21: Loteamento Moradas do Sul 1

Planta de Localização





**Prefeitura de
Porto Alegre**

**MUNICÍPIO DE PORTO ALEGRE
DEPARTAMENTO DE ESGOTOS PLUVIAIS - DEP
EQUIPE DE LICITAÇÕES E CONTRATOS – ELC**



Situação 2008

Situação atual

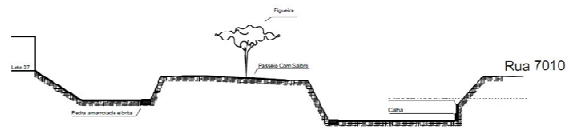
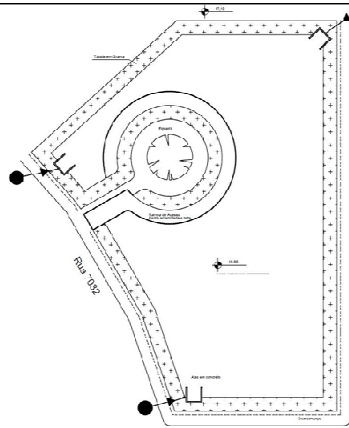

Reservatório 22: Loteamento Moradas do Sul 2

Planta de Localização





**Prefeitura de
Porto Alegre**

**MUNICIPIO DE PORTO ALEGRE
DEPARTAMENTO DE ESGOTOS PLUVIAIS - DEP
EQUIPE DE LICITAÇÕES E CONTRATOS – ELC**



Situação 2008

Situação atual

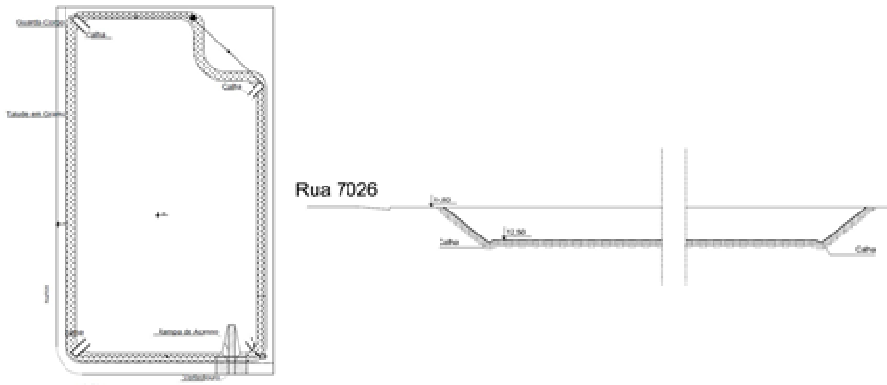

Reservatório 23: Residencial Caminhos do Sol

Planta de Localização





Prefeitura de
Porto Alegre

MUNICIPIO DE PORTO ALEGRE
DEPARTAMENTO DE ESGOTOS PLUVIAIS - DEP
EQUIPE DE LICITAÇÕES E CONTRATOS - ELC



Situação 2008

Situação atual

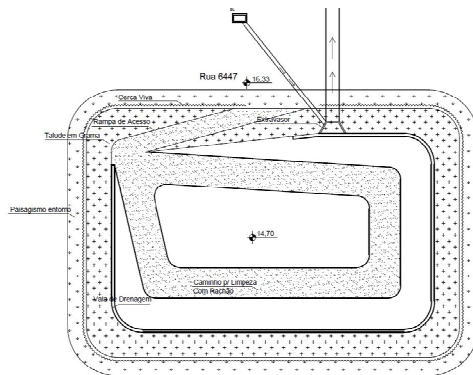

Reservatório 24: Parque Empresarial Condor

Planta de Localização





**Prefeitura de
Porto Alegre**

**MUNICIPIO DE PORTO ALEGRE
DEPARTAMENTO DE ESGOTOS PLUVIAIS - DEP
EQUIPE DE LICITAÇÕES E CONTRATOS - ELC**



Situação 2008

Situação atual

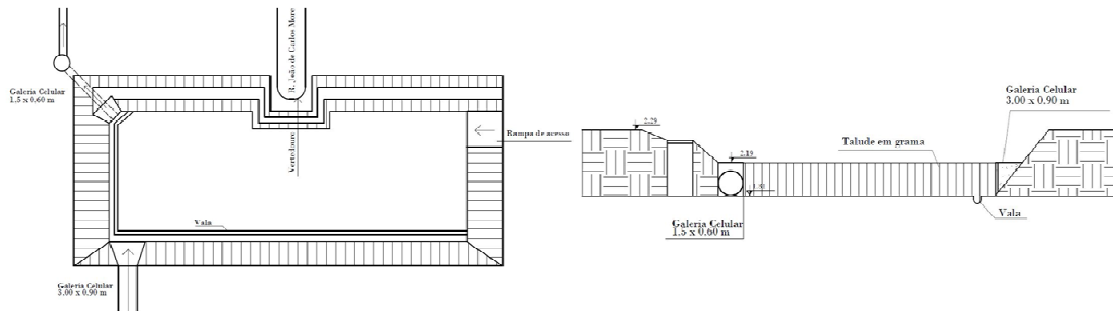

Reservatório 25: Loteamento Campos do Conde 1

Planta de Localização



Situação 2008

Situação atual

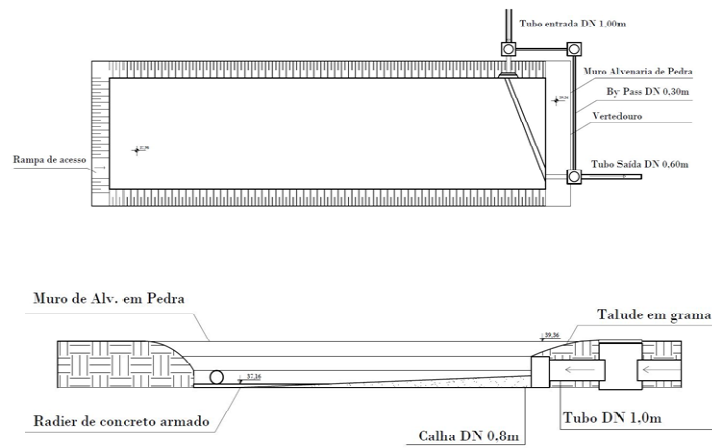

Reservatório 26: Loteamento Campos do Conde 2

Planta de Localização



Situação 2008

Situação atual

